

CITY OF NORTHAMPTON
MASSACHUSETTS

In the Year Two Thousand and Fifteen

Upon the Recommendation of Office of Planning and Sustainability

An Ordinance of the City of Northampton, Massachusetts, providing that the Code of Ordinances, City of Northampton, Massachusetts, be amended by revising section 350, 350B, 350 C of said code; updating layout for the SR district and eliminating nursing care/assisted living, junk cars, modifying setbacks for ground mounted PV among other changes.

ORDINANCE

An Ordinance of the City of Northampton, Massachusetts. Be it ordained by the City Council of the City of Northampton, in City Council assembled, as follows:

SECTION 1

That §350-B of the Code of Ordinances be amended as follows:

Delete “SR” column in its entirety

and

That §350C of the Code of Ordinances be amended as follows:

Delete section on dimensions for RR district from this table.

Add new “Table of Use and Dim Regs SR” as the following

SR District (Suburban Residential)

Description:

Lower density residential and agricultural land. Conservation cluster design is encourage. Areas are typically not within walking distance of goods/services some private and water services required. Within transect-based zoning SR is a T3 Sub-Urban zone.

Example Uses/Structures



Lot Dimension Requirements

Lot Size- standard -
 30,000 square ft. minimum (80,000 square ft. if private water & sewer)
 Frontage/Width = 125' Min.
 Depth = 160' Min.

Setbacks (principal and detached accessory structures –Det. Acc.)
 Front =30' Min
 Side= 15' Min (10' Det Acc structure)
 Rear= 30' Min (10' Det Acc structure)

Max Height
 35' (20' Det Acc Structure)

Open Space = 70%

Layout Setbacks

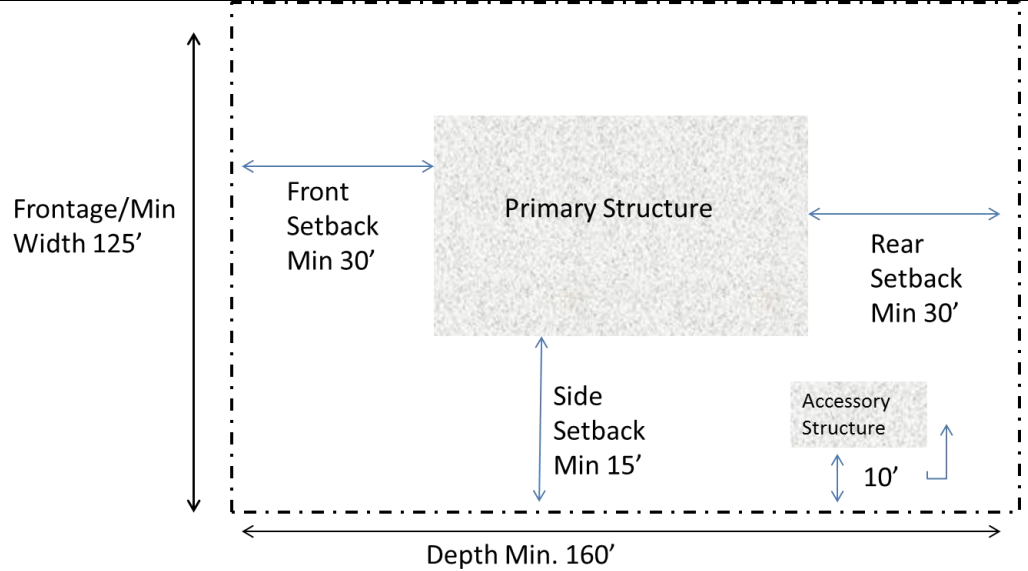

Flag Lot Size-

60,000 square ft. minimum (80,000 square ft. if private water & sewer)
 Frontage/Width = 50' Min.
 Depth = 160' Min.

Setbacks
 Front =60' Min
 Side=30' Min(10' Det Acc structure)
 Rear=60' Min(10' Det Acc structure)

Max Height = 35'
Open Space = 85%

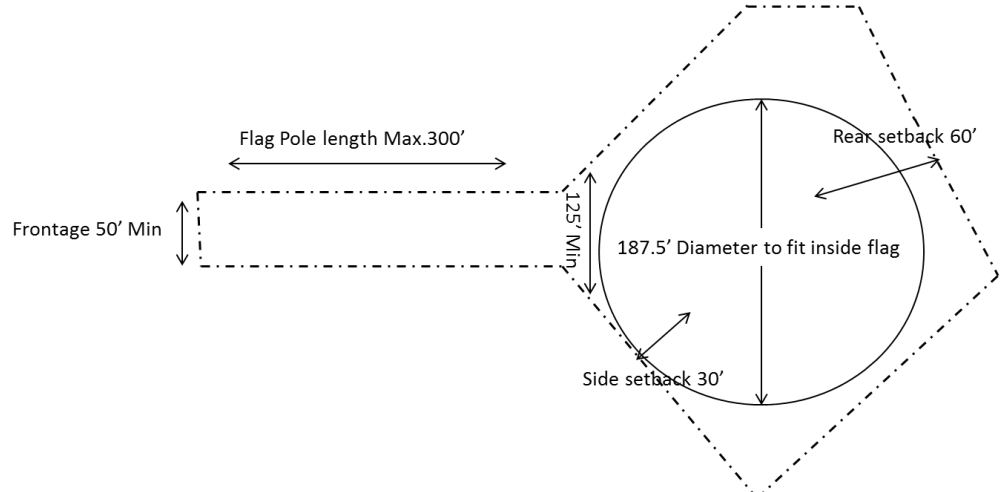

FLAG LOT LAYOUT



Design Standards Illustrated

Planning Board may waive, by site plan approval element 2, if it can be shown that a different design meets a pedestrian-scale design that encourages public/private transition and interface (e.g. similar elements facing internal courtyards or private streets)

1. If a garage or other parking structure is attached, it shall comprise no more than 30% of the front facade of the primary structure.

-  Primary Structure
-  Garage or Parking Structure
-  Area

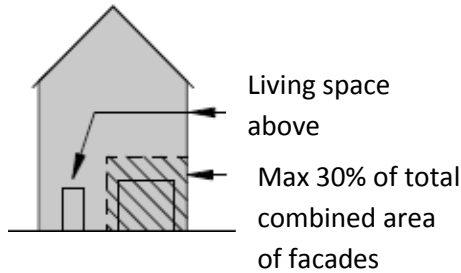
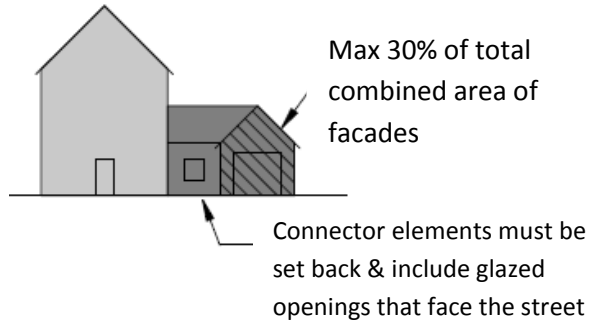

DOESN'T FIT

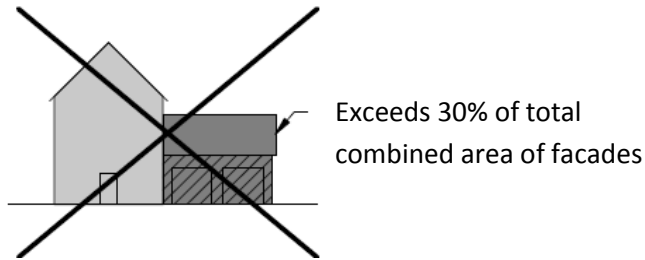
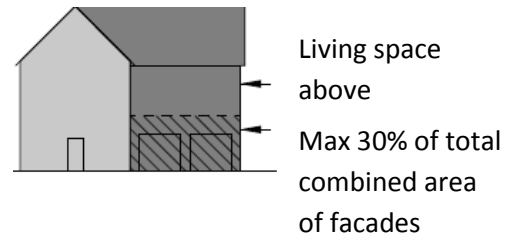

Minimum Parking for residential uses

1 space per 1,000 ft² Gross Living Area (round up). No more than 2 spaces required per unit.

For other uses see table in 350-8.2

Front yard setback may only have parking for a maximum of two vehicles

SR USES ALLOWED

Uses Allowed By Right:

- Single Family residence
- Attached(to a single family) accessory dwelling unit not to exceed 900 F² Gross Living Area. See 350-10.10. Same setback as for principal structures.
- Home Business up to 25 visits per week as defined in sect.2.1
- Preexisting nonconforming uses (may trigger ZBA permit)
- Accessory uses to residential: Tag Sales -temporary sales of personal and household articles, Pets/animals section 5.3
- Accessory structures- detached (but no larger than 1,000 ft² of lot coverage or 3% of lot area whichever is greater unless it is used for agricultural purposes) See also § 350-6.7.
- Family day care (registration w/Building Commissioner required)
- Cemetery, including any crematory therein
- Temporary event as defined in 350-2.1
- Agriculture, horticulture, floriculture, noncommercial forestry, the growing of all vegetables and a temporary (not to exceed erection or use for a period of four months in any one year) greenhouse or stand for retail sale of agricultural or farm products raised primarily on the same premises
- Rooftop solar hot water and photovoltaic
- Accessory solar photovoltaic(PV) ground-mounted on a parcel with any building/ use, provided that the PV is sized to generate no more than 100% or 12 KW of the annual projected electric use of the non-PV building/use. Same setbacks as for detached accessory structures.
- Essential Facilities
- Municipal Facility

Site Plan Approval required for the following:

- Any Construction (other than for a single family home) greater than 2,000 ft²
- Detached accessory dwelling unit for single family home meeting same setback requirements as a single family home see §350-10.10. --*Administrative Site Plan*
- Educational use: non-profit, any religious use, day care, school-aged child-care program (MGL c. 28A, § 9) and
- Reuse of Historic Educational or Religious Building(s) for: Any residential use, live/work space, or office, provided however that no more than 20% of the floor space of the building(s) shall be used for medical, banking or any offices where a primary function is to provide services to retail customers or individuals. All such uses approved under this provision shall be within the footprint of existing building(s) and may only be approved contingent upon protection of all historically contributing portions of the building with a Historic Preservation Restriction granted to the City of Northampton in a form acceptable to the Planning Board, with input from the Historical Commission, as preserving the key character defining features visible from the road (and not necessarily meeting federal or state preservation standards for the entire building). The existing building may be expanded to accommodate elevators and stairwells. Portions of the building that are not part of the original architecture of the building and which do not contribute to the historical or architectural significance of the building as determined by the Planning Board, with input from the Historical Commission, may be demolished.
- Solar photovoltaic of any size, ground-mounted—*Administrative Site Plan*:
 1. Over any legal parking lot or driveway;
 2. At any landfill site not separate from the site-assigned property by any road; and
 3. At an airport not separated from the runways by any road
- Parking off site and combined parking. See § 350-8.5 and 350-8.7
- Creation or expansion of six or more parking spaces.
- Parking requirement reduction. See § 350-8.10F.
- Residential Shared driveways [see § 350-8.8R](#)
- Year-round greenhouse / stand for wholesale and retail sale of agricultural farm products raised on site
- Detached Accessory Dwelling Unit see 10.10—*Administrative Site Plan*

- Telecommunication antennas which are located on existing telecommunications towers or other structures which do not require the construction of a new tower (in accordance with § 350-10.9)

Special Permit Approval required for the following uses by Planning Board unless otherwise noted:

- Home Business for personal service business by appointment only or Home Business more than 25 visits etc. see 10.12 for other criteria—*Zoning Board of Appeals Special Permit*
- Flag lots. See § 350-6.13.
- Tourist home/bed-and-breakfast
- Community center
- Commercial stable or kennel in which all animals, fowl, or other forms of life are completely enclosed in pens or other structures. See § 350-10.8 and exemptions MGL c. 40A.
- Outdoor Commercial Recreational use, miniature golf, temporary carnival
- Any other private school, college or university
- Historical association or society and nonprofit museum (may include the residence of a caretaker)
- Accessory solar photovoltaic ground-mounted on a parcel with any building or use, between 8 KW or over 100% but no more than 200% of the annual projected electric use of the non-PV building or use.
- Private Utility or Substation, small scale hydroelectric generation.
- New Telecommunications facility in accordance with §§350-2.1 and 10.9.
- Parking lot access for nonresidential uses across a residential lot. See § 350-8.9.
- Processing and treating of raw materials including operations appurtenant to the taking, such as grading, drying, sorting, crushing, grinding and milling operations. See § 350- 10.3.
- Removal of sand, gravel, quarry, or other raw material. See § 350-10.3.
- Filling of any land see §10.4. Filling of water or any wet area See §10.3.
- Private bridge, tunnel
- Railroad passenger terminal
- Municipal facility
- Heavy public use. See § 350-10.7.—*City Council Special Permit*
- Membership club operated as a not-for-profit corporation, as defined by MGL c. 180, excluding any adult establishments which display live nudity - *City Council Special Permit*
- Cluster residential development. See § 350-10.5.

Cluster Development Layout Standards

- a. Project lot = 4-acre minimum
- b. Project frontage = 125 feet
- c. Project depth = 160 feet
- d. Setbacks from project boundary:
 - Front = 30 feet
 - Side = 15 feet
 - Rear = 30 feet
- e. Individual lot frontage, setbacks, frontage = 0 feet
- f. Maximum height = 35 feet
- g. Project open space = 75%
- h. Design: Planning Board to review layout to ensure project transitions between existing neighborhood along street and proposed project. For new buildings, setback, scale, massing should fit within the area. Mature specimen trees shall be preserved unless shown to be infeasible. No minimum setbacks, lot size, frontage, or open space for internal lots. More than one structure may be located on a single lot.